



Radial Flux In-Wheel-Motors for Vehicle Electrification

Mahmoud Said Jneid

 <https://orcid.org/0000-0001-5407-285X>

Budapest University of Technology and Economics

Budapest, Hungary

mah.jneid@edu.bme.hu

Peter Harth

 <https://orcid.org/0000-0003-4400-3986>

Budapest University of Technology and Economics

Budapest, Hungary

harth.peter@kjk.bme.hu

Abstract

In-wheel motors (IWMs) have emerged as a promising technology for vehicle electrification, offering enhanced efficiency, compactness, and design flexibility compared to traditional onboard motors. The independent and direct drive capability of IWMs allows for the advanced application and integration of a wide range of chassis active safety systems, including anti-lock braking systems (ABS), traction control systems (TCS), electronic stability control (ESC), and torque vectoring (TV). IWM manufacturers utilise toroidal motor stators for IWM electric vehicle applications where axial length minimisation is essential. An outer rotor topology with radial flux Neodymium permanent magnets allows for hosting a higher number of pole-pairs on the rotor circumference enables accommodation of a higher number of pole pairs on the rotor circumference, significantly enhancing the power and torque densities compared to traditional cylindrical motors. Inspired by early conceptual IWMs introduced by pioneering automotive and tyre manufacturers, major automotive companies today have developed unique IWM designs, each with distinguishing features. The Protean IWM stands out for its high torque density, high efficiency, fault tolerance, direct drive, and improved packaging, making it an optimal choice for a propeller. This paper explores the state-of-the-art radial flux IWMs tailored specifically for electric vehicle (EV) applications. The unique features of the Protean IWM are examined in more detail due to its potential as a propeller suitable for both retrofitting traditional vehicles with minimal tear-out and for new electrified vehicles. Finally, a comparison of the features of various IWMs is conducted, highlighting the unique strengths of each system.

Keywords

In-wheel-motor, off-wheel-motor, Protean motor, radial flux, vehicle electrification.

1. Introduction

IWM drivetrains have emerged as cutting-edge technologies that have received huge interest from researchers and manufacturers in the automotive domain due to their numerous advantages. IWMs answer questions concerning the development of the next-generation EVs and provide optimal solutions that take vehicle electrification to a new horizon. Future EVs are seen to be more sustainable, energy-efficient, environmentally friendly, simple structure, compact design, lightweight, fewer elements, reduced mechanical maintenance, flexible design, wide passenger and cargo spaces, high integration, and improved dynamics and ride comfort. Furthermore, reducing emissions and energy consumption from these technological innovations encourages consumers and industries to adopt cleaner, more sustainable transportation solutions (Silva, Ross and Farias, 2009).

Traditional EVs with central propulsion systems using off-wheel motors (OWMs) are far from answering these requirements. Therefore, to meet the previous demands, IWMs should be designed precisely to have specific features such as high power and torque density, direct drive, fault-tolerant, lightweight, compact volume, and high efficiency. As a result,



IWMs will represent a complete departure from traditional centralised propulsion systems into distributed propulsion by integrating electric motors (EMs) directly into the wheels' rim.

The adoption of IWM drivetrains eliminates the need for several mechanical and electrical parts, including transmission, drive shafts, and mechanical and electrical connections, while allowing using shorter power cables compared to OWM drivetrains, offering numerous advantages in terms of energy efficiency, interior-free space, and cost (Fraser Alexander, 2018). Furthermore, power electronics, drive control, and sensors can all be integrated into the motor body and housed inside the wheel rim, allowing for more compactness and efficient energy consumption. From a control perspective, installing the EM inside the wheel rim enables direct drive, independent and precise driving/braking torque control, and efficient traction due to optimal utilisation of road friction. Individual control of each wheel torque allows for a better drive with the capability of applying advanced active safety systems like TCS, ABS, ESC, and TV (Said Jneid and Harth, 2023c, 2023a, 2023b). The optimal torque distribution over the four wheels improves the vehicle's performance and dynamics while maintaining energy efficiency (Said Jneid, Harth and Ficzero, 2020). This way, the mechanical connections that transfer driver commands can be replaced by electrical ones, which realise a pure control system called by-wire. With by-wire control, almost all active chassis safety systems can be implemented electronically, enabling new versions (-e). Examples of -e active controls are eABS, eTCS, eESC, and eTV. Different chassis active safety systems can be integrated using shared actuators and sensors, producing a holistic chassis active safety system that reduces elements, space, and cost.

However, some considerations must be taken into account when adopting IWMs. One common concern is the impact of increased unsprung mass on driving performance, as they add extra weight and complexity to the drivetrain (Biček et al., 2015). The increased unsprung mass increases vertical vibration, impacting ride comfort and safety (Anderson and Harty, 2010; Said (Jneid, Harth and Ficzero, 2020; De Carvalho Pinheiro, Messana and Carello, 2022). Ride comfort and vibration can be improved using dynamic suspension with a vibration absorption structure, an additional spring damper, and a controllable damper (Nagaya, Wakao and Abe, 2003).

Fortunately, systems attached to the wheels, like braking system, steering, and suspension, can also be integrated with the IWMs, enabling active IWM system, which takes vehicle integration to new heights (Said Jneid, Harth and Ficzero, 2020). This holistic approach simplifies chassis and vehicle architecture, enhances handling and ride comfort by minimising unsprung mass, improves chassis active control and integration, and maintains vehicle safety. Nevertheless, the last generation of IWM can provide high performance and comfortable riding with no unsprung mass degradation, as the case for the Michelin concept, Bridgestone dynamic-damping IWM drive system, and the advanced Protean 360⁺ electric-drive corner module (Hag, 2011; US Equal Employment Opportunity Commission, 2019; Wang and Chen, 2019).

EVs that use IWMs can be either a front-wheel drive with two IWMs on the front drive axle or a rear-wheel drive with two IWMs on the rear drive axle. When all-wheel-drive is required, four IWMs are fitted, enabling maximum performance and control. Figure 1 shows the different drivetrain topologies when using IWMs (Said Jneid, Harth and Ficzero, 2020).

EVs equipped with IWMs have several advantages in terms of control and safety, efficiency, and packaging:

- Changeable drivetrain layout of front-wheel drive, rear-wheel drive, and four-wheel-drive
- EMs are connected directly to the wheels and aligned with the drive axle
- Minimum mechanical losses
- High efficiency
- High level of control integration between different active safety systems, e.g., active steering, TCS, ABS, ESC, and TV

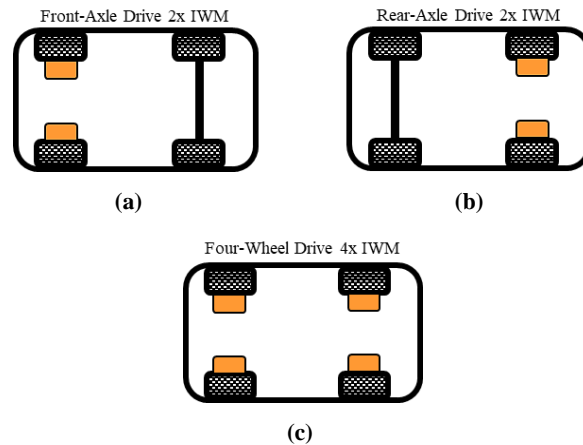

Figure 1: Different drivetrain topologies with IWMs (a): front-wheel-drive with two-IWM, (b): rear-wheel-drive with two-IWM, (c): all-wheel-drive with four-IWM, (Said Jneid, Harth and Ficzer, 2020).

To highlight the design changes in vehicle drivetrain structure when IWMs are used, Figure 2 shows a traditional internal combustion engine (ICE) vehicle with a rear-wheel drivetrain retrofitted into a conventional EV with OWMs drive in Figure 3 and then transformed into an EV with "Protean" IWMs drive in Figure 4. For traditional ICE vehicles, the drivetrain system consists of conventional mechanical systems, including the engine, transmission, exhaust, driveshaft, and differential. In a conventional EV with OWMs, the engine is replaced by a central EM with an inverter and a set of batteries installed at the back, but both the transmission and the driveshaft, in addition to the differential, remain. In the case of EVs that use IWMs, all the mechanical subsystems of the powertrain are eliminated (engine, transmission, driveshaft, and differential) and replaced with direct drive IWMs connected directly to the wheels. However, the conventional suspension is the only remaining system in this type of EV.



Figure 2: Chassis and drivetrain layout of traditional rear-wheel drive vehicle (Vallance, 2011).



Figure 3: Chassis and drivetrain layout of a retrofitted electric vehicle with OWM (Vallance, 2011).



Figure 4: Chassis and drivetrain layout of a retrofitted electric vehicle with IWM (Vallance, 2011).

As the automotive industry continues to embrace electrification and autonomous driving, IWMs play a pivotal role in shaping the future of mobility.

This paper aims to explore the state-of-the-art radial flux in-wheel motors (IWMs) designed specifically for electric vehicle (EV) applications, focusing on their unique features, such as enhanced power and torque densities, efficiency, and fault tolerance. By conducting a detailed examination of the Protean IWM and comparing various IWM systems, this study provides insights into how these innovative technologies offer optimal solutions for advancing vehicle electrification and transforming future EV design.

The remainder of the paper is structured as follows. Sec. 2 provides the history of IWMs, Sec. 3 highlights the requirements of IWMs as propulsion systems, Sec. 4 introduces the conceptual IWMs early models, Sec. 5 explores the state-of-the-art radial flux IWMs for vehicle electrification focusing on the design features and advantages of Protean IWM, its work concept, and its potential for fault tolerance, Sec. 6 provides a comparative summary of the state-of-the-art radial flux IWMs discussed in section Sec. 5, at the same time, Sec. 7 concludes the work.

2. History of In-Wheel-Motors

As EVs were introduced before the ICE vehicles, the concept of IWMs was also introduced before OWMs as a propeller system with a first patent dating back to the first hub motor that used a brushed DC motor with a planetary gear in 1884. Next, in 1990, The idea was integrated into the Lohner-Porsche EV, featuring a pair of IWMs that propelled the vehicle to speeds above 56 km/h (Watts et al., 2010). Later, Volvo introduced the autonomous corner module (ACM) in 1998 (Rajaie, 2016). In the summer of 2003, Bridgestone unveiled its dynamic-damping IWM drive, showcasing the potential for improved handling and efficiency by mounting the EM on a specifically designed suspension system, all of which are integrated within the wheel hub. This model represented a significant leap forward in integrating propulsion systems into the vehicle chassis. Inspired by the innovations of its predecessors, Michelin introduced its active wheel system in 2004, after almost eight years of research and development in 1996 (Michelin, 2008). Michelin Active Wheel was a highly integrated propulsion and drivetrain system with active suspension.

The introduction of the Siemens VDO eCorner in 2006 marked a milestone in developing IWM technology, offering a comprehensive solution for vehicle electrification by integrating EM, brakes, and suspension components into a single module (Gerling, Dajaku and Lange, 2007). Next, the robot wheel-5 was developed at the MIT Media Lab and unveiled in 2007, showcasing active suspension and a broad steering angle capability (Schmitt, 2007). However, the concept of IWMs has endured over the past two decades and has undergone significant evolution as a requirement of the widespread adoption of electric vehicles. Today, several automotive manufacturers and research institutions are actively developing IWMs, working on innovating and producing highly efficient IWMs that address the challenges and integration requirements posed by future EV development. Despite this, each company produces a unique IWM that is distinguished from others by motor type used, performance capacity, level of integration, and potential applications.

3. Requirements of In-Wheel-Motors as Propulsion System

Various types of motors can function as in-wheel motors, such as permanent magnet synchronous motors (PMSMs), switched reluctance motors (SRM), synchronous reluctance motors (SynRM), and induction motors (IM) (Yu et al., 2023). Because of their higher energy density, PMSMs are the most commonly chosen option nowadays. However, the selection of the IWM for EV applications must fulfil several requirements, including:

- High volumetric torque density



- High instant and continuous torque
- High torque at low-speed range for start-up and uphill working conditions
- Low inertia and rapid response
- Lightweight for minimising unsprung mass and rotational mass
- Low cogging torque and torque ripple
- High efficiency in both constant torque and constant power regions
- Robust and fault-tolerant, capable of withstanding demanding and challenging operating conditions
- High endurance
- Compact design with a short axial length

4. Conceptual In-Wheel-Motor Models

Major automotive and tyre manufacturers have developed various IWM models along with research centres such as Volvo, Michelin, Bridgestone, Siemens VDO, and MIT. Michelin and Bridgestone have introduced active wheels by embedding the suspension and the IWM within the wheel rim. The Volvo autonomous corner module concept is designed with independent, active steering and active suspension functions through additional actuators. Further, a specialised IWM with collapsible links was suggested for a foldable chassis designed for smart-connected cars. The MIT robot-wheel-5 concept is a good example of a steer-by-wire (SBW) system. Siemens e-Corner system represents an advanced model integrating the IWM, active suspension, independent steering, and electronic wedge brakes, providing a comprehensive example of a fully chassis-by-wire (CBW) IWM. The following subsections thoroughly examine the key concepts underlying IWMs, their design, and application.

4.1. Volvo Autonomous Corner Module

The Volvo Autonomous Corner Module (ACM), illustrated in Figure 5, is a Volvo innovation developing since 1998 (Rajaie, 2016). This system incorporates an IWM, an electro-mechanical braking system, an active suspension, and active steering with the capability to adjust the wheel camber angle. The IWM power is within the range of 10-15 kW, resulting in a total power of 40-60 kW for all four wheels sufficient to propel a sports car weighing 1000 kg (Kałuza and Kornaszewski, 2017). Electric braking with energy recovery to the batteries is possible by operating the motor in generator mode. In instances of heavy braking, the electro-mechanical brake is activated to support the EM (Hag, 2011). ACM was first introduced on the Volvo ReCharge C30 hybrid car with four ACM on all wheels (Vallance, 2011).

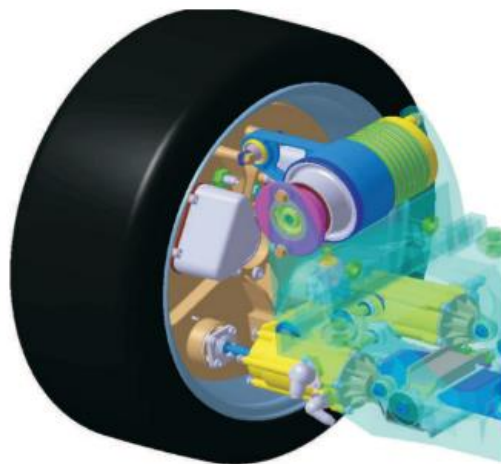

Figure 5: Schematic diagram of Volvo's Autonomous Corner Module, (Jonasson, Zetterström and Stensson Trigell, 2006).

4.2. Michelin Active Wheel

Michelin has effectively developed the Michelin active wheel (MAW) system, as shown in Figure 6, since 1996, specifically designed for EV applications (Li and Qian, 2012). All essential propulsion, braking, steering, and suspension components are integrated (Yu, Evangelou and Dini, 2023). MAW incorporates two EMs, one functioning as an IWM propeller while the other operates the active suspension. This system was first introduced in 2004 on a HY-Light vehicle with hydrogen fuel cells as its primary energy source. Subsequently, the Michelin Wheel system was applied to the modified Heuliez Will vehicle, based on the Opel Agila model, which saw faster market penetration than the HY-Light vehicle. The



Opel vehicle incorporated two Michelin wheel drive systems cooled by water, mounted on the front drive axle, generating a total power of 30 kW, and each integrated system weighing 42 kg (Hooper, 2011).

Although wheel corner modules (WCM) systems are designed to function as an integrated direct-drive system without the need for transmission, gearboxes, or shafts, the Michelin active wheel incorporates an internal gearbox to multiply wheel torque, making it suitable for low-speed and high-torque applications. The system functions as regenerative braking when the vehicle decelerates at a low rate within motor power capacity; otherwise, friction brakes are activated to provide additional torque during hard braking conditions. The active suspension system that MAW is equipped with isolates wide-range vibrations arising from road pumps (Jandura, Břoušek and Bukvic, 2015). Furthermore, this system is designed with a wheel steering system based on a traditional steering linkage, allowing integration with either a traditional steering system or the advanced electrically operated system mounted on the vehicle chassis. However, due to concerns over the unacceptable increase in weight, space requirements within the wheel, and associated economic costs, the project was halted in 2014.

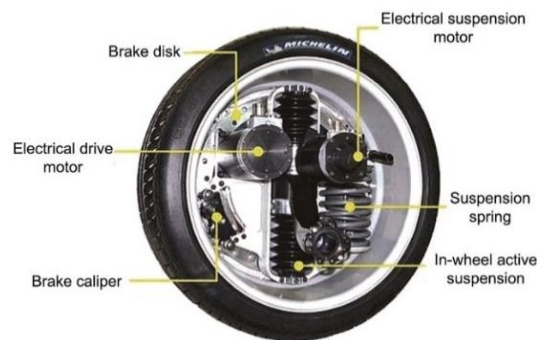

Figure 6: Michelin Active Wheel, (Jandura, Břoušek and Bukvic, 2015).

4.3. Bridgestone Dynamic-Damping In-Wheel-Motor Drive System

The collaboration between Bridgestone Corporation, Kayaba Industry, and Akebono Brake has yielded the development of the Bridgestone dynamic-damping IWM drive shown in Figure 7 (Rajaie, 2016). This innovative IWM system was first introduced in 2003. They are addressing challenges related to performance and ride comfort arising from the increased wheel mass of IWMs. Bridgestone has devised a unique suspension system tailored for their motor. In this novel approach, the EM is mounted on a special suspension, distinct from the main suspension, to mitigate the vibration resulting from the vehicle's additional unsprung mass.

Consequently, the vibrations from the motor and those from the road effectively cancel each other, improving the road-holding performance. The company asserts that applying this motor-specific suspension system results in an enhanced level of road hold and ride comfort. The transmission of motor torque to the wheels is facilitated through a flexible system featuring three disc-like hollow plates with guides. This coupling mechanism allows for a relative vertical movement of 50mm between the rotor and the wheel. Furthermore, the Bridgestone IWM system supports regenerative braking. When the electric torque proves inadequate to bring the vehicle to a stop, the electro-mechanical friction braking system intervenes, providing the torque required by the driver. An analytical study was conducted at Bridgestone to compare the road-holding performance (road surface-tyre contact force fluctuation) and the ride comfort (vertical acceleration). The study covers three EVs equipped with Bridgestone IWM drive, conventional IWM, and single OWM. Results showed improved road-holding performance and ride comfort of the EV with Bridgestone IWM drive compared to the other two EVs.



Figure 7: Bridgestone Dynamic-Damping In-Wheel Motor Drive System (Omar and Özkan, 2015).

4.4. Siemens VDO eCorner

The Siemens VDO eCorner system depicted in Figure 8 is an advanced drive system incorporating an IWM, an active suspension, and an electronic wedge brake (EWB) system (Gerling, Dajaku and Lange, 2007). The IWM is designed with an outer rotor suitable for direct drive, enabling cohesive integration between the motor rotor and wheel (Kałuża and Kornaszewski, 2017). Additionally, this system can function in regenerative braking mode, directing recaptured energy back to the battery pack to bring the vehicle to a halt (Jonasson, Zetterström and Stensson Trigell, 2006).

In hard braking scenarios or when the EM falls short of meeting the required braking torque, EWB intervenes to top up the braking torque deficiency (Jonasson and Wallmark, 2008). EWB operates based on a self-energising concept capable of multiplying minimised actuation force from the actuator into a massive braking force (Said Jneid and Harth, 2023a). EWB represent a brake-by-wire (BBW) system comprised of an electric actuator, a precisely designed brake wedge, friction pads, and a disc brake calliper (Siemens VDO, 2006).



Figure 8: Siemens VDO eCorner, wheel rim (1); wheel hub motor (2); electronic wedge brake (3); suspension (4); electronic steering (5). Source: Siemens VDO Automotive AG, (Gerling, Dajaku and Lange, 2007)

4.5. MIT Media Lab Robot Wheel-5

A team of researchers at the MIT Media Lab have developed several models of spoke robot wheels (RWs), with the latest model being RW-5, as illustrated in Figure 9. The main aim of this design was to minimise the unsprung mass as much as possible by reducing the number of components to a minimum (Wang and Chen, 2019). This system can operate independently; hence, it is called the robot wheel. The EM used within this wheel is a brushless three-phase motor with 12 permanent magnet poles and an outer rotor. The braking system, coupled with regenerative braking to recharge the battery



pack, is also available and capable of meeting demands under various braking conditions. Therefore, this system is not equipped with an additional friction brake.

In comparison to other systems, the RW-5 model also features an active suspension and active steering system (Hag, 2011). The distinctive feature of this system is the wide wheel steering angle of up to 150° . A vehicle equipped with RW-5 at each wheel can be steered in five different modes: front-wheel steering at $\pm 30^\circ$ similar to traditional systems, four-wheel parallel steering, four-wheel opposite steering, turning around a point with the front wheels steered inside and rear wheels steered outside, and lateral movement with a wheel steering angle of $\pm 90^\circ$ (Carvajal, 2009).

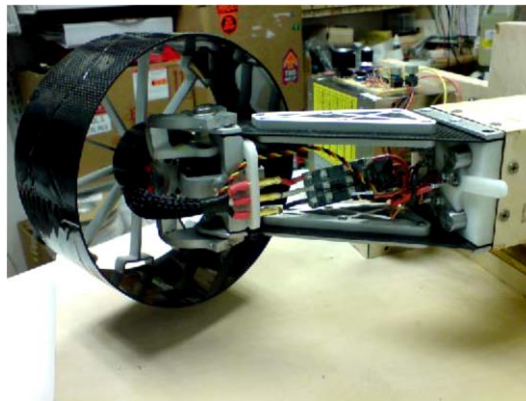

Figure 9: MIT Media Lab Robot Wheel-5 (Schmitt, 2007).

5. State-of-the-art radial Flux IWMs for Vehicle Electrification

In the previous section, the conceptual IWM Models are explored, highlighting the foundational concepts and early developments in the field of IWMs. In recent years, significant advancements have been made, driven by the urgent need for vehicle electrification and the ongoing need for more sustainable transportation solutions. This section aims to provide a detailed overview of the latest innovations, cutting-edge designs, and advancements in integrating IWMs as a compact drivetrain across various automotive industry sectors. Getting inspiration from the conceptual IWM models earlier, several companies started the development of advanced IWM units, each with a unique design, specifications, and target applications.

The following subsections present various IWM models designed specifically to meet the requirements of future EVs. Radial flux IWMs adhere to the conventional early concept of electric motors, where the magnetic lines are oriented radially between the stator and the rotor through the air gap. However, in radial flux IWMs, there are two topologies for the rotor's location, the inner and outer rotors, depending on the application area. In the EV domain with direct drive, the outer rotor is preferred as it has inherited high torque density due to the higher pole number. It can also be fitted adequately on the wheel rim, providing more space inside the wheel.

Nevertheless, the inner rotor is preferred for EVs with a central drivetrain using OWMs. Radial flux IWMs can employ PMSM, SRM, SynRM, or induction motors (IM) (Deepak et al., 2023). However, PMSM is the optimal choice for EV applications due to its high torque density from using Neodymium permanent magnets. Various manufacturers develop several radial flux IWMs, each offering unique features and capabilities tailored to meet specific application requirements.

5.1. Magnet-Motor IWM Drive Unit

Magnet-Motor (MM) produced high power, high torque in-hub-motor M70 for automotive applications, as shown in Figure 10. Its design features compactness, allowing for the integration of a friction brake or even a gearbox when torque multiplication is required. The motor is designed with an inner rotor and water-cooling intended for applications that require direct drive and high torque, such as directly driven wheels, hybrid EVs, compact military fleets, agricultural machinery, and industrial systems with high torque demand. A single or dual M70 unit can prove sufficient for normal performance.

However, high-performance vehicles can be equipped with four M70 units, providing an extreme performance suitable for various working conditions. The M70 is built for tough tasks. Operating at a peak power of 100 kW at 750V, it delivers a maximum torque of 1050 Nm and at a continuous power of 50 kW, it boasts a continuous of 500 Nm utilising a water/glycol cooling system. The motor has a medium-rated speed of 2200 RPM, fitting direct drive EV applications, eliminating the need for a gearbox to adjust torque or speed. Designed at a high-rated voltage of 750V (maximum 800V), it allows for

minimised volumetric size and reduced copper cross-section. The reduced total weight is only 34 kg, making it compact and lightweight for easy integration into various vehicle designs. Additionally, the M70 boasts a shock resistance of 50g, ensuring durability in challenging environments (Magnet-Motor).



Figure 10: Magnet-Motor M70 radial flux IWM (Magnet-Motor).

5.2. GEM-Motors IWM Drive Unit

GEM Motors introduced RF-IWM with concentrated winding and inner rotor at a wide power range from 1 kW to 15 kW. Several generations with different specifications have been introduced, including G0, G1.1, G1.3, G2.4, G2.6, and recently G3. The G3 electric motor, shown in Figure 11, is a synchronous multi-phase motor tailored for various applications. It is well-suited for EVs with two to four-wheels and robotic applications, thanks to its modular mounting options and availability in various speed ranges. Potential applications include personal cars, light cargo vehicles, commercial vehicles, automated vehicles, farm robots, and small/light vehicles. Operating within a voltage range of 48 to 70 V, this motor delivers a peak/continuous power of 30/15 kW, max torque of 500 Nm and a speed of 1000 RPM with relatively high efficiency of up to 91% with a. It utilises permanent magnets and has an integrated controller for seamless operation (Deepak et al., 2023).

Featuring field-oriented control (FOC), the motor incorporates a regenerative braking system and four-quadrant mode operation, facilitating efficient energy usage. It offers compatibility with controller area network (CAN) 2.0 or analogue signal interfaces, enabling remote monitoring and control. Additionally, it has an ingress protection of IP67, ensuring resistance against various environmental contaminants such as salt, water, dust, acid, and alkali. G3 is available in a single/double-sided-mount configuration. The motor compact package measures 330x131 mm, making it suitable for diverse installation requirements (Products – GEM Motors | In-wheel motors and electric drive solutions, 2024).

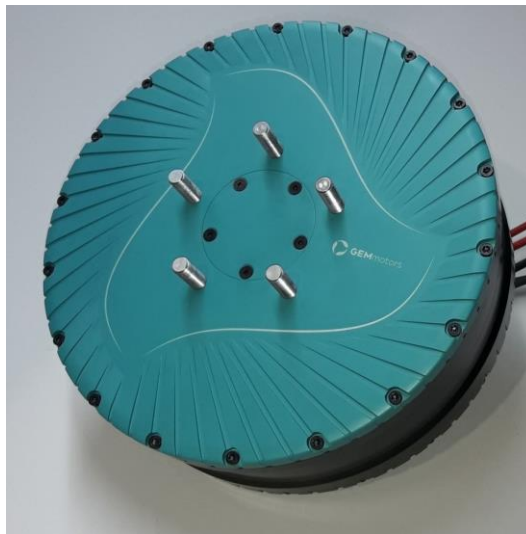

Figure 11: GEM-Motors G3 radial flux IWM (Products – GEM Motors | In-wheel motors and electric drive solutions, 2024).

5.3. Elaphe IWM Drive Unit

Elaphe designs a series of high-performance radial flux IWMs suitable for various EV applications. Elaphe IWMs are designed as a direct drive with a concentrated winding configuration and an outer rotor, making them suitable for vehicle electrification and retrofitting. The Elaphe L1500 shown in Figure 12 has a peak power of over 200 kW, a maximum/continuous torque exceeding 2000/1000 Nm, and max speeds of up to 3000 RPM, making it an optimal option for heavy-duty tasks. It ensures optimal energy utilisation with a remarkable motor efficiency exceeding 97 % and system efficiency of up to 95%. Active parts have a specific torque of up to 100 Nm/kg and volumetric torque above 500 Nm/L, demonstrating exceptional power-to-weight and power-to-volume ratios, making them a compact and efficient choice for wide-range EV applications. Its compatibility with rim sizes ranging from 16 to 23 inches allows for versatile integration into various vehicle designs. The total unit mass ranges from 25 to 65 kg depending on the rim size, ensuring lightweight and minimum added unsprung mass compared with other IWM units at the same size, ensuring minimal impact on overall vehicle weight (Technology - Elaphe, 2024).



Figure 12: Elaphe L1500 radial flux IWM (Gallery - Elaphe, 2024).

5.4. PWM Dynamics IWM Drive Unit

PWM Dynamics produces the XR IWMs series, representing a significant advancement in electric motor technology. XR IWMs are designed based on radial flux PMSM topology with an outer rotor configuration suitable for EV applications with direct drive. Outer rotor configuration ensures that motor torque is delivered directly to the wheel, maximising its geometric advantage for enhanced efficiency and power output. Furthermore, the XR series benefits from water cooling, enabling efficient heat dissipation even under demanding operating conditions. Its key feature is the ultra-flat compact pancake design,



allowing for seamless integration into various vehicle architectures. The high slot fill achieved by using concentrated winding on each stator tooth also results in maximum torque density, further enhancing motor performance and shortening its axial length.

PWM Dynamics introduced a wide range of IWMs with various specifications that fit various applications. The list includes XR20-09, XR20-09 WC, XR25-05, XR15-03, XR32-13, XR32-11, XR15-05, XR15-W, XR15-06, XR44-16 WC, and XR32-13 WC. The latest XR32-13 WC motor shown in Figure 13 is a notable iteration within the XR series and shows impressive performance tailored for diverse applications. With a peak power/continuous of 120/62 kW and a current rating of 322Arms, it offers robust performance capabilities to meet various torque and power requirements, delivering max/continuous torque of 577/300 Nm. Operating at a speed of 2000 RPM at a DC link voltage of 100V ensures compatible vehicle speed without needing a speed reducer. The water-cooled motor weighs only 32 kg, making it a versatile solution for IWM EV applications (XR32-13 WC - PMW, 2024).



Figure 13: PWM Dynamics XR32-13 WC radial flux IWM, (XR32-13 WC - PMW, 2024).

5.5. Protean IWM Drive Unit

Protean Electric reshaped the IWM paradigm by introducing an advanced IWM drive distinct from the field counterparts, as depicted in Figure 14. The company ingeniously changed the element position of its drive unit. Protean adopts the "inside-out" approach, where the stator is moved inside while the rotor is moved outside the motor (Fraser and Whitehead, 2012). This way not only multiplies the motor torque but also brings a new level of motor integration within the wheel assembly. This configuration creates enough space where the power electronics can be embedded into the stator body and share the water cooling system (Fraser Alexander, 2018).

Furthermore, the friction braking with the brake disc is moved from the inner wheel to the outer side, improving the friction heat transfer to the environment (Perovic, 2012; Whitehead, 2012). The stator is divided into eight sub-motors, providing a high fault tolerance that is substantial for EV applications. Currently, Protean is working on a future advanced electric-drive corner module designed for next-generation high-performance mobility called Protean 360+, shown in Figure 15 (Technology - Protean : Protean, 2024 a; Technology - Protean : Protean, 2024 b).

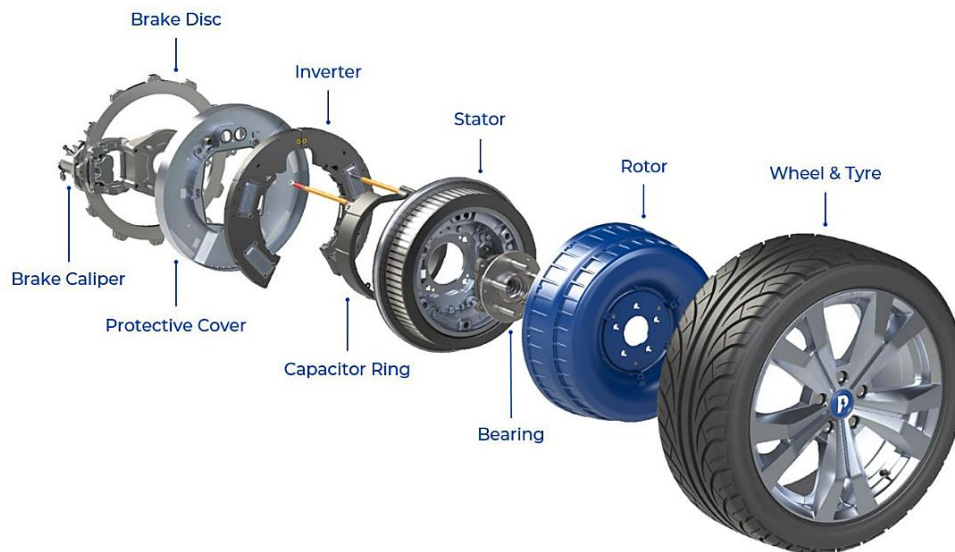

Figure 14: Protean Pd18 radial flux IWM with embedded power electronics exploded view (Technology - Protean : Protean, 2024 a).

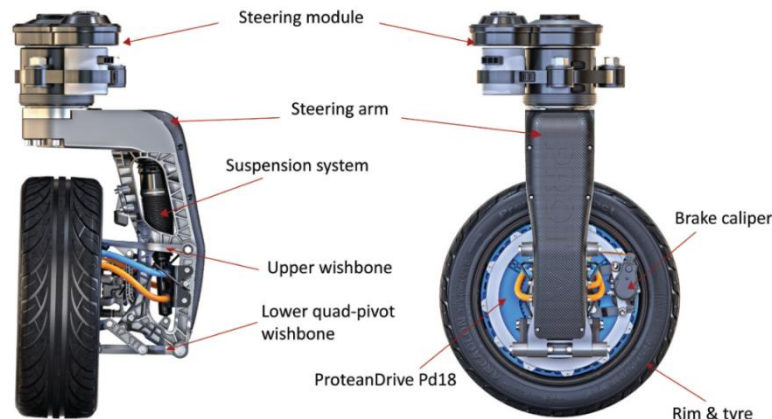

Figure 15: Protean 360+ drive corner module designed for next-generation mobility (Technology - Protean : Protean, 2024 b).

5.5.1. Components of Protean In-Wheel-Motor Unit

The Protean drive system comprises the components outlined in Figure 14, showing an exploded view of the electric motor with its drive elements, including:

- Standard wheel and tyre
- Outer rotor with surface-mounted permanent magnets fitting traditional wheel rim
- Internal stator with concentrated coils
- Drive unit with micro-inverters
- Water-cooling jacket for stator and micro-inverter heat transfer
- Outer ring brake disc
- Friction brake callipers
- Steering and suspension mountings and bearing

5.5.2. Design Features and Advantages of Protean In-Wheel-Motor

Protean IWM design is based on adopting the unique "inside-out" concept, which allows for high integration between the IWM and drives. Inside-out means the motor stator is relocated inside while the rotor is moved outside. This can be done by adopting a toroidal motor rather than a conventional cylindrical shape. This concept not only multiplies the torque density due to a larger air-gap diameter and, hence, a larger number of rotor poles but also frees up more space in the motor core where electronics can be integrated (Fraser Alexander, 2018). Although this way presents tough demands on the electronic design, it significantly cuts down on the needed cabling, where only two shielded DC cables are necessary (Aloeyi, Ali and Wang, 2022). This improves efficiency, reduces cost, and makes integration much easier while opening up more space in the vehicle, enhancing the flexibility of the in-wheel motor concept.



The Protean IWM drive unit has the following characteristics and features:

- Direct drive, eliminating mechanical elements such as gears and shafts
- 64 PM poles for high torque density
- External hollow rotor with a radial configuration
- Sub-motors configuration (up to 8) for high fault tolerance
- Concentrated winding for more fault tolerance
- High performance in both constant torque and power regions
- High efficiency
- High reliability

5.5.3. Fault Tolerant Concept of Protean-In-Wheel-Motor

The principle of fault tolerance in machine design was initially introduced in aviation, where high energy density, operational readiness, and reliability are crucial requirements (Muenchhof, Beck and Isermann, 2009). However, this concept is also applicable and essential in the design of machines used in EVs. In the event of a malfunction, such as a failure in any wheel during driving, it might generate significant pulling or braking torque, posing the vehicle with a substantial risk. This situation can be catastrophic, particularly at high speeds. According to Protean, they generate disturbance torque during a fault condition of approximately 280Nm or higher, leading to a loss of control over the vehicle (Ifedi et al., 2011). Therefore, designing the motor with minimum faults in mind is imperative. Previous attempts to achieve a high fault-tolerance motor often focused on increasing the number of phases. Still, these efforts proved unsuccessful due to the substantial torques generated by common faults (such as a short circuit), which can be highly risky (Yepes et al., 2022).

In addition, the selection of poles and slots considers critical aspects like resistance to demagnetisation, prevention of excessive rotor temperature, and the feasibility of subdividing the motor into independent sub-motors. This subdivision is crucial for creating a highly fault-tolerant in-wheel motor system, aligning with the specified requirements outlined earlier (Wolnik, Styskala and Mlcak, 2022). To address these considerations, Protean has segmented the motor into eight independent sub-motors, adopting a configuration of 72/64 slots/poles. Each sub-motor features three phases spanning 45°/360° mechanical/electrical on the stator periphery. Mechanical displacement between subsequent phases within each sub-motor is 15°/120° mechanical/electrical. Each sub-motor boasts 9/8 slots/poles and a dedicated micro-inverter for independent control, ensuring fault tolerance and optimised performance. In the event of a malfunction in one of the eight sub-motors, a braking torque equivalent to one-eighth of the total motor torque is generated. The remaining seven healthy motors continue to deliver the required operational torque.

However, when the performance of one sub-motor is compromised, the system is expected to provide the full nominal torque, distributing the load of the affected sub-motor among the remaining sub-motors. The overload factor for each remaining sub-motor is $(n-1)/n$, where n represents the number of sub-motors ($n=8$). Consequently, each sub-motor experiences an additional load of one-seventh of the torque from the faulted sub-motor. For the vehicle, the braking torque resulting from the failure of one sub-motor does not impact its functionality, as it is still powered by a total of 31 sub-motors over the four wheels. The maximum braking torque generated when a short circuit occurs between two phases in one sub-motor is 50 Nm. This value is less than 20% of the disturbance torque, leading to a hazardous loss of control (280 Nm).

This method of dividing the motor into eight sub-motors ensures the required safety level and fault tolerance. However, in a traditional, non-divided stator, the disturbance torque would be around 400 Nm, exceeding the critical value where the vehicle loses stability (Ifedi et al., 2012). To prevent the propagation of the fault, regardless of its nature, it is crucial to minimise the impact of a fault in one sub-motor on its adjacent counterparts. This ensures that the remaining healthy motors continue to function normally. Achieving this involves designing the motor to minimise the magnetic coupling between adjacent sub-motors. Therefore, the distribution of the three-phase coils for each sub-motor ensures that only one coil out of nine shares magnetic flux with one coil from the adjacent sub-motors, as shown in Figure 16.

Nevertheless, the thermal coupling between these two coils can be high. In this case, it has been found that the reduction in the electromagnetic force of a motor adjacent to the affected motor is only 3.3%, with negligible impact (Ifedi et al., 2012). This indicates that the adjacent motor will continue to operate as expected.

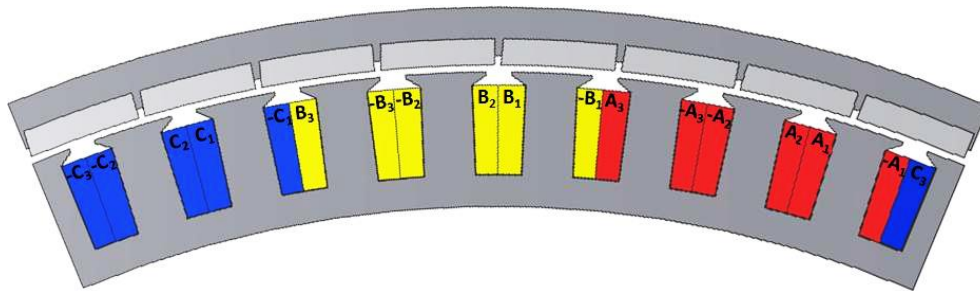

Figure 16: Three-phase winding of 9/8 slots/poles sub-motor configuration with one shared slot mitigating fault propagation (Ifedi et al., 2012).

5.5.4. Protean In-Wheel-Motor Concept and Control

Figure 17 illustrates a schematic representation of Protean sub-motors and micro-inverters, where each sub-motor with its dedicated micro-inverter forms an individual three-phase drive unit with independent control. All units are isolated but share the common DC-link connection and Controller Area Network (CAN) communication bus. Each micro-inverter is connected to the DC link through a thermal fuse to prevent fault propagation on the system level. In case of a large current flow due to a fault in one of the sub-motors or its drive system, the thermal fuse collapses, isolating the damage propagation to the other sub-units. Furthermore, the control signal from the CAN communication channel is optically isolated in each micro-inverter to prevent any fault in one micro-inverter from affecting the others.

Additionally, each micro-inverter has its own DC-Link capacitor and its drive circuits. The vehicle's main electronic control unit (ECU) receives the total torque command, divides it by eight, and delivers it to individual sub-motor micro-inverters, where each contributes one-eighth of the total torque. In case one sub-motor is faulted, the total torque is divided by seven, and in this case, each sub-motor contributes one-seventh overload.

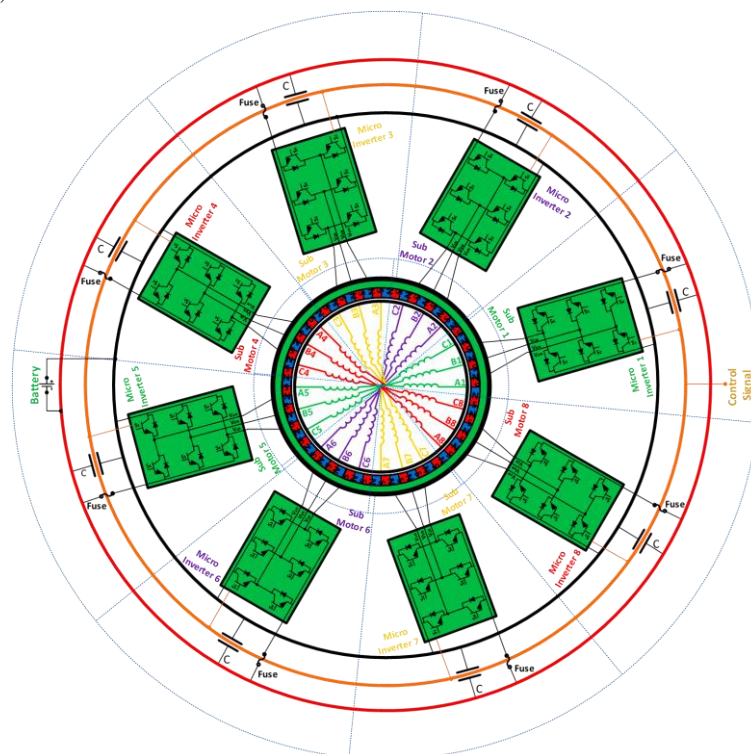

Figure 17: Individual sub-motors with dedicated micro-inverters shared common DC-link and CAN bus control.

5.5.5. Specifications and Design Features of Radial Flux IWMs

In this section, the state-of-the-art radial flux IWMs discussed in the previous section are summarised and compared in terms of peak power and torque, continuous power and torque, peak power and torque densities, peak efficiency, max speed, voltage range, mass, dimensions, drivetrain topology, motor topology, cooling system, ingress protection level, integration with other systems, and fault tolerance. Table 1 provides a comparative summary of the state-of-the-art radial flux IWMs discussed in this section.



Table 1: Specifications and design features of state-of-the-art radial flux IWMs

IWM Unit	Magnet-Motor M70	GEMmotors G3	Elaphe L1500	PWM Dynamics XR32-13 WC	Protean Pd18	Protean Pd16
Power (Peak/ Continuous) [kW]	100/50	30/15	177/110	5.87/4.9	90/60	40/26
Torque (Peak/ Continuous) [Nm]	1050/500	550/370	1250/650	577/300	1400 (3sec)/1250 (18sec)/650	800/450
Max Speed [RPM]	2200	1300	3000	2000	1600	1600
DC Voltage [V]	750-800	48-100	370	100	150-430	150-430
Peak Efficiency [%]	-	System: 93	Motor: 97 System: (motor + inverter): 95	-	System (motor + inverter): 93	System (motor + inverter): 93
Mass [kg]	34	27	25	32	IWM + Inverter 36	IWM + Inverter 28
Wheel Rim Size Min [inch]	-	15	19	14	18	16
Peak Power Density [kW/kg]	2.9	1.11	7.1	0.18	2.5	1.4
Peak Torque Density [Nm/kg]	30.9	20.4	50	18	38.9	28.6
Winding Topology	-	Concentrated	Distributed	Distributed	Concentrated	Concentrated
Rotor Topology/ Poles No	Inner-Rotor	Outer-Rotor/24	Outer-Rotor/-	Outer-Rotor/-	Outer-Rotor/64	Outer-Rotor/64
Stator Topology Slots/Poles	Outer-Stator/-	Inner-Stator/18	Inner-Stator/-	Inner-Stator/-	Inner-Stator/72	Inner-Stator/72
Drivetrain Topology	Direct-Drive	Direct-Drive	Direct-Drive	Direct-Drive	Direct-Drive	Direct-Drive
Reducer / Gear-Ratio	Optional	-	-	-	-	-
Cooling System	Water/Glycol 50/50	Forced Air	Water	Water	Water/Glycol 50/50	Water/Glycol 50/50
Fault Tolerance	-	-	-	-	- Stator division into eight sub-motor - Winding electrical insulation - Winding magnetic isolation	- Stator division into eight sub-motor - Winding electrical insulation - Winding magnetic isolation
Integration level	IWM Only	IWM+ Inverter	IWM+ Brakes	IWM only	IWM + Inverter + Wheel Bearing + Brakes	IWM + Inverter + Wheel Bearing + Brakes
Ingress Protection Level	IP68	IP67	IP67 and IPX9K	-	IP69	IP69
Dimensions [mm]	Ø 437 x 134	Ø 330 x 131	Ø 232 x 142.2	Ø 324.5 x 130	Ø 433 x 125	Ø 380 x 125
Ref	(Magnet-Motor M70 Datasheet)	(Products – GEM Motors In-wheel motors and electric drive solutions)	(Technology - Elaphe, no date; Elaphe L1500 in-wheel motor - E-Mobility Engineering, no date; Deepak et al., 2023)	(XR32-13 WC - PMW, no date; Deepak et al., 2023)	(Technology - Protean : Protean, 2024 c)	(Technology - Protean : Protean, no date c);>Protean Electric and Zhejiang VIE Science & Technology Jointly Announce the Development of PD16 to Broaden the In-Wheel Motor Market Access - Protean : Protean, 2024)



5. Conclusion

Electric vehicles equipped with IWM systems demonstrate a remarkable leap in performance, control integration, and simple design compared to their traditional counterparts. This advancement is attributed to the innovative chassis-by-wire technology, complemented by additional actuators that ensure precise control over the vehicle's motion. CBW facilitates superior management of longitudinal, lateral, and vertical movements, coupled with the effective integration of advanced active safety systems. Various automotive companies have developed different IWM models with unique specifications featuring the CBW control substantial for next-generation EVs. Almost all IWM models used permanent magnet electric motors, known for their high torque density and lightweight, resulting in exceptional efficiency, particularly in the constant torque range. Protean Electric emerged as a leader in this domain and introduced a distinctive IWM design with a high level of integration, high fault tolerance, and torque density. The unique design of Protean IWM as a direct drive enables seamless integration into traditional electric vehicles without significant structural modifications. Consequently, amongst all presented IWMs, Protean IWM stands out as the optimal choice for vehicle electrification.

Acronyms

ACM	Autonomous Corner Module
ACAS	Advanced Chassis Assistance Systems
AWM	Active Wheel Module
BBW	Brake-By-Wire
CAN	Controller Area Network
CBW	Chassis-By-Wire
DYC	Direct Yaw Control
eABS	Electronic Version ABS
eESC	Electronic Version ESC
EM	Electric Motor
ESC	Electronic Stability Control
eTCS	Electronic Version TCS
eTV	Electronic Version TV
EV	Electric Vehicle
EWB	Electronic Wedge Brake
ICE	Internal Combustion Engine
IM	Induction Motor
IWM	In-Wheel-Motor
MAW	Michelin Active Wheel
OWM	Off-Wheel-Motor
PD18	Protean in-wheel-motor former model
PM	Permanent Magnet
PMSM	Permanent Magnet Synchronous Motor
RW	Robot Wheel
SBW	Steer-By-Wire
SRM	Switched Reluctance Motor
SynRM	Synchronous Reluctance Motor
TCS	Traction Control System
TV	Torque Vectoring
WCM	Wheel Corner Module

References

- Aloeyi, E. F., Ali, N. and Wang, Q. (2022) 'A Review of In-Wheel Motors for Electric Vehicle Propulsion', 2022 IEEE Transportation Electrification Conference and Expo, Asia-Pacific, ITEC Asia-Pacific 2022, pp. 1–6. DOI: <https://doi.org/nj78>
- Anderson, M. and Harty, D. (2010) 'Unsprung Mass with In-Wheel Motors - Myths and Realities', *Avec*, pp. 261–266. Available at URL: <http://www.proteanelectric.com/wp-content/uploads/2011/12/protean-Services3.pdf>
- Biček, M. et al. (2015) 'Mechanical failure mode causes of in-wheel motors', *Strojnicki Vestnik/Journal of Mechanical Engineering*, 61(1), pp. 74–85. DOI: <https://doi.org/nj8b>
- Carvajal, M. A. (2009) 'The Design Process for Wheel-Robot Integration by'.
- De Carvalho Pinheiro, H., Messana, A. and Carello, M. (2022) 'In-wheel and onboard motors in BEV: lateral and vertical performance comparison', 2022 IEEE International Conference on Environment and Electrical Engineering and 2022 IEEE Industrial and Commercial Power Systems Europe, IEEEIC / I and CPS Europe 2022, pp. 1–6. DOI: <https://doi.org/nj8c>
- Deepak, K. et al. (2023) 'In-Wheel Motor Drive Systems for Electric Vehicles: State of the Art, Challenges, and Future Trends', *Energies*, 16(7), pp. 1–31. DOI: <https://doi.org/nj8d>
- Elaphe L1500 in-wheel motor - E-Mobility Engineering (no date). Available at URL: <https://www.emobility-engineering.com/elaphe-11500-in-wheel-motor/> (Accessed: 20 May 2024).
- Fraser, A. and Whitehead, A. (2012) 'In-Wheel Technologies How are Brakes being Redefined?', Protean, (November). Available at URL: http://www.proteanelectric.com/en/wp-content/uploads/2013/07/In_Wheel_Tech_Brakes_Redefined_AF_AWh_V611132012b.pdf.



- Fraser Alexander (2018) 'IN-WHEEL ELECTRIC MOTORS The Packaging and Integration Challenges', pp. 1–15. Available at URL: <https://www.proteanelectric.com/f/2018/04/In-Wheel-Electric-Motors-AFraser-ProteanV4.pdf>.
- Gallery - Elaphe (no date). Available at URL: <https://in-wheel.com/en/gallery-2/> (Accessed: 19 May 2024).
- Gerling, D., Dajaku, G. and Lange, B. (2007) 'Electric traction for automobiles - Comparison of different wheel-hub drives', Electric Drive Transportation Association - 23rd Int. Electric Vehicle Symposium and Exposition 2007, EVS 2007 (Battery, Hybrid, Fuel Cell) Conf. Proc. - Sustainability: The Future of Transportation, 1, pp. 218–227.
- Hag, J. (2011) 'Wheel Corner Modules'.
- Hooper, I. (2011) 'Development of in-Wheel Motor Systems for Formula SAE Electric Vehicles', (November), p. 149.
- Ifedi, C. J. et al. (2011) 'Fault tolerant in-wheel motor topologies for high performance electric vehicles', 2011 IEEE International Electric Machines and Drives Conference, IEMDC 2011, pp. 1310–1315. DOI: <https://doi.org/dsngq2>
- Ifedi, C. J. et al. (2012) 'A high torque density, direct drive in-wheel motor for electric vehicles', IET Conference Publications, 2012(592 CP). DOI: <https://doi.org/nj8f>
- Jandura, P., Břoušek, J. and Bukvic, M. (2015) 'The concept of a highly efficient powertrain for an electric vehicle with respect to vehicle driving dynamics', 2015 International Conference on Electrical Drives and Power Electronics, EDPE 2015 - Proceedings, (December), pp. 422–429. DOI: <https://doi.org/gf64hx>
- Jin, X. et al. (2023) 'Improving Vibration Performance of Electric Vehicles Based on In-Wheel Motor-Active Suspension System via Robust Finite Frequency Control', IEEE Transactions on Intelligent Transportation Systems, 24(2), pp. 1631–1643. DOI: <https://doi.org/nj8g>
- Jonasson, M. and Wallmark, O. (2008) 'Control of electric vehicles with autonomous corner modules: Implementation aspects and fault handling', International Journal of Vehicle Systems Modelling and Testing, 3(3), pp. 213–228. DOI: <https://doi.org/c3fqsj>
- Jonasson, M., Zetterström, S. and Stensson Trigell, A. (2006) Autonomous corner modules as an enabler for new vehicle chassis solutions, FISITA World Automotive Congress.
- Kałuża, S. and Kornaszewski, M. (2017) 'THE ACTIVE WHEELS SYSTEMS', pp. 1208–1210.
- Li, X. and Qian, H. (2012) 'The present status and future trends of in-wheel motors for electric vehicles', Advanced Materials Research, 433–440, pp. 6943–6950. DOI: <https://doi.org/fzqxfc>
- Magnet-Motor M70 Datasheet (no date) 'Automotive In-Hub Motor'.
- Michelin (2008) 'Michelin Active Wheel Drive', Michelin, (October).
- Motor, A. I. (no date) 'Automotive In-Hub Motor Torque'.
- Motor, M. (no date) 'Engineering Expertise MM's products'.
- Muenchhof, M., Beck, M. and Isermann, R. (2009) Fault Tolerant Actuators and Drives – Structures, Fault Detection Principles and Applications, IFAC Proceedings Volumes. IFAC. DOI: <https://doi.org/bdk4t3>
- Nagaya, G., Wakao, Y. and Abe, A. (2003) 'Development of an in-wheel drive with advanced dynamic-damper mechanism', JSAE Review, 24(4), pp. 477–481. DOI: <https://doi.org/dvhxsc>
- Omar, A. A. A. and Özkan, B. (2015) 'Analysis of effect of in-wheel electric motors mass on passive and active suspension systems', ARPN Journal of Engineering and Applied Sciences, 10(14), pp. 5924–5928.
- Perovic, D. K. (2012) 'Making the impossible, possible-overcoming the design challenges of in wheel motors', World Electric Vehicle Journal, 5(2), pp. 514–519. DOI: <https://doi.org/nj8h>
- Products – GEM Motors | In-wheel motors and electric drive solutions (no date). Available at: <https://www.gemmotors.si/products/#gem-g-3> (Accessed: 15 May 2024).
- Protean Electric and Zhejiang VIE Science & Technology Jointly Announce the Development of PD16 to Broaden the In-Wheel Motor Market Access - Protean : Protean (no date). Available at URL: <https://www.proteanelectric.com/protean-electric-and-zhejiang-vie-science-technology-jointly-announce-the-development-of-pd16-to-broaden-the-in-wheel-motor-market-access/> (Accessed: 16 May 2024).
- Rajaie, M. (2016) 'Design and Fabrication of a Novel Corner Wheel Module for Urban Vehicles'.
- Said Jneid, M. and Harth, P. (2023a) 'Blended Regenerative Anti-Lock Braking System and Electronic Wedge Brake Coordinate Control Ensuring Maximal Energy Recovery and Stability of All-Wheel-Motor-Drive Electric Vehicles', Journal of Transportation Technologies, 13(03), pp. 465–495. DOI: <https://doi.org/nj8j>



- Said Jneid, M. and Harth, P. (2023b) 'Coordinate Torque Vectoring Control For Enhancing Handling and Stability of All-Wheel-Drive Electric Vehicles Through Wheel Slip Control Integration', in 2023 IEEE Cognitive Mobility Conf. (CogMob). Budapest, Hungary: IEEE, pp. 177–186.
- Said Jneid, M. and Harth, P. (2023c) 'Integrated Braking and Traction Torque Vectoring Control Based on Vehicle Yaw Rate for Stability Improvement of All-Wheel-Drive Electric Vehicles', in 2023 IEEE International Conference on Electrical Systems for Aircraft, Railway, Ship Propulsion and Road Vehicles & International Transportation Electrification Conference (ESARS-ITEC), Venice, Italy. IEEE, pp. 1–6. DOI: <https://doi.org/nj8k>
- Said Jneid, M., Harth, P. and Ficzer, P. (2020) 'In-Wheel-Motor Electric Vehicles And Their Associated Drivetrains', International Journal For Traffic And Transport Engineering, 10(4). DOI: <https://doi.org/nj8m>
- Schmitt, P. (2007) 'Just Build It ! A Fully Functional Concept Vehicle Using Robotic Wheels', (1954).
- Siemens VDO (2006) 'technical innovations Siemens VDO drives toward the future', (October). Available at URL: <https://www.sae.org/ohmag/techinnovations/10-2006/11-14-6-6.pdf>.
- Silva, C., Ross, M. and Farias, T. (2009) 'Evaluation of energy consumption, emissions and cost of plug-in hybrid vehicles', Energy Conversion and Management, 50(7), pp. 1635–1643. DOI: <https://doi.org/bdv75c>
- Technology - Elaphe (no date). Available at URL: <https://in-wheel.com/en/technology/#in-wheel-motor-technology> (Accessed: 15 May 2024).
- Technology - Protean : Protean (no date a). Available at URL: <https://www.proteanelectric.com/technology/#overview> (Accessed: 19 May 2024).
- Technology - Protean : Protean (no date b). Available at URL: <https://www.proteanelectric.com/technology/#protean360plus> (Accessed: 19 May 2024).
- Technology - Protean : Protean (no date c). Available at URL: <https://www.proteanelectric.com/technology/#overview> (Accessed: 15 May 2024).
- US Equal Employment Opportunity Commission (2019) 'Fact sheet Fact sheet', Nursing and Midwifery Board of Australia, 440(July), pp. 1–5.
- Vallance, A. (2011) 'Advanced In-Wheel Electric Propulsion Technology', Www.Proteanelectric.Com, (April). Available at URL: <http://www.proteanelectric.com/wp-content/uploads/2013/07/Protean-Electric-presentation-for-PAES.pdf>.
- Wang, W. and Chen, X. (2019) 'Design methodology for wheel corner module topology based on position and orientation characteristics', Mechanism and Machine Theory, 136(4800), pp. 122–140. DOI: <https://doi.org/nj8n>
- Watts, A. et al. (2010) 'The technology and Economics of In-Wheel Motors', SAE International Journal of Passenger Cars - Electronic and Electrical Systems, 3(2), pp. 37–54. DOI: <https://doi.org/dhmnng>
- Whitehead, A. (2012) 'Plug-in hybrids made easy - Selectable EV drive using in-wheel motors', 26th Electric Vehicle Symposium 2012, EVS 2012, 4, pp. 2361–2372.
- Wolnik, T., Styskala, V. and Mlcak, T. (2022) 'Study on the selection of the number of magnetic poles and the slot-pole combinations in fractional slot PMSM motor with a high power density', Energies, 15(1). DOI: <https://doi.org/nj8p>
- XR32-13 WC - PMW (no date). Available at: <https://www.pmw-dynamics.com/product/xr32-13-wc/> (Accessed: 15 May 2024).
- Yepes, A. G. et al. (2022) 'A Comprehensive Survey on Fault Tolerance in Multi-phase AC Drives, Part 1: General Overview Considering Multiple Fault Types', Machines, 10(3), pp. 1–134. DOI: <https://doi.org/gpx35j>
- Yu, M., Evangelou, S. and Dini, D. (2023) 'Advances in Active Suspension Systems for Road Vehicles', Engineering. DOI: <https://doi.org/nj8q>
- Yu, Y. et al. (2023) 'Performance Comparison Between Permanent Magnet Synchronous Motor and Vernier Motor for In-Wheel Direct Drive', IEEE Transactions on Industrial Electronics, 70(8), pp. 7761–7772. DOI: <https://doi.org/nj8r>